

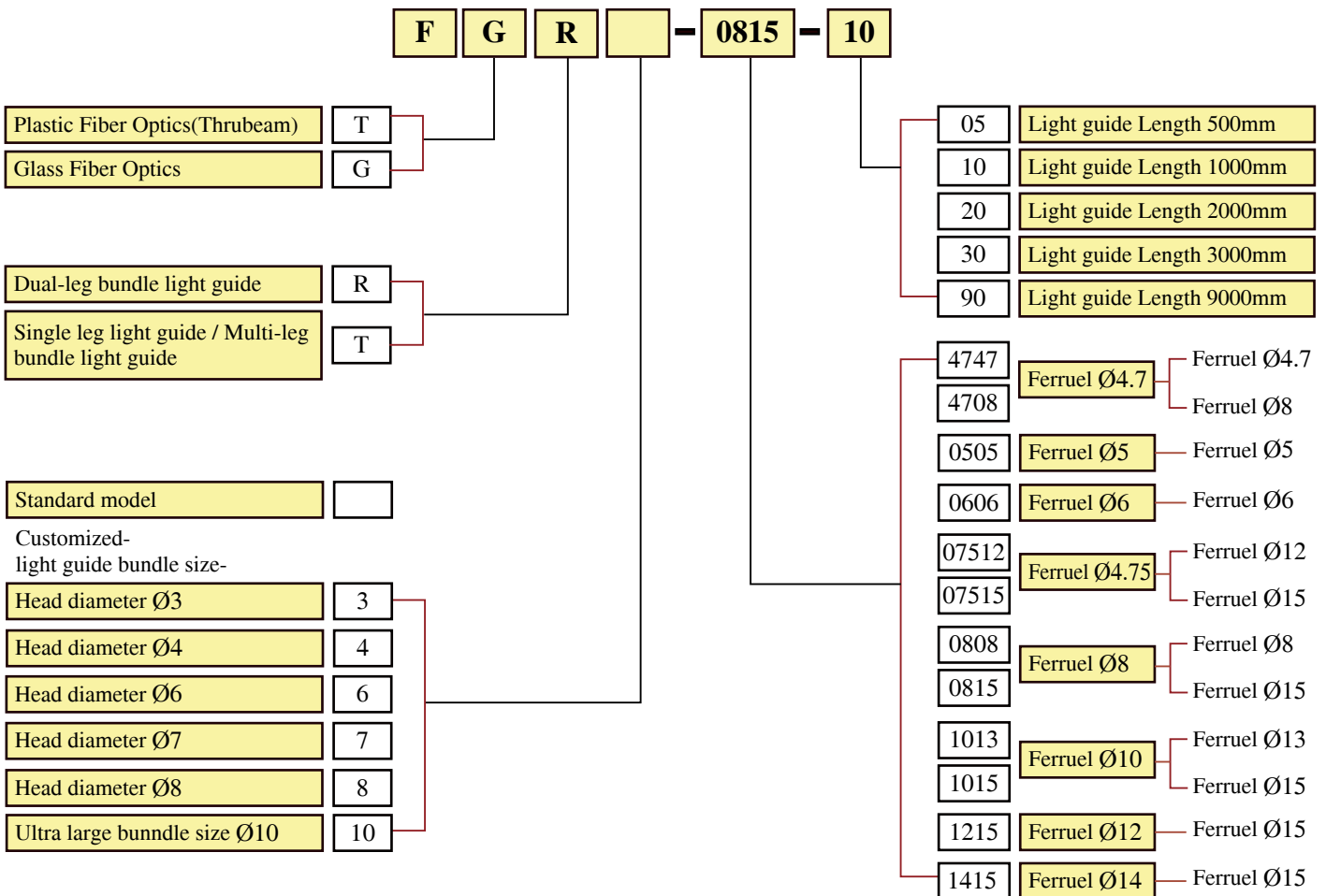

Light Guide TYPE

Fiber customized for special dimension

◆Order Information :



Fiber

PR /PT

FR /FT

Glass Fiber

Light Guide

Silica Fiber

Access

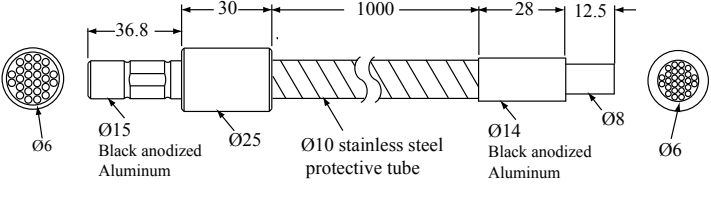
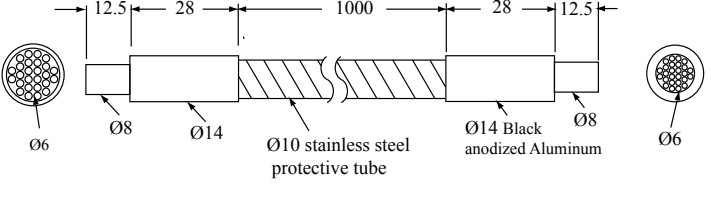
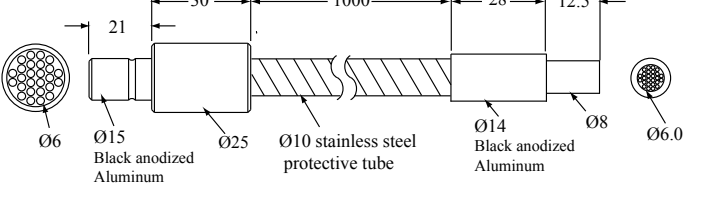
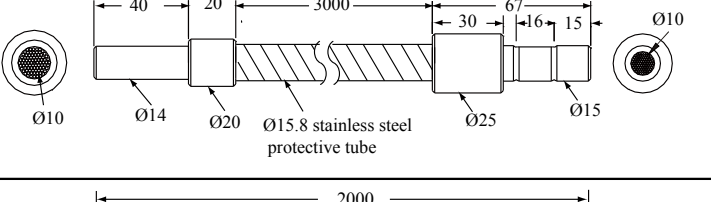
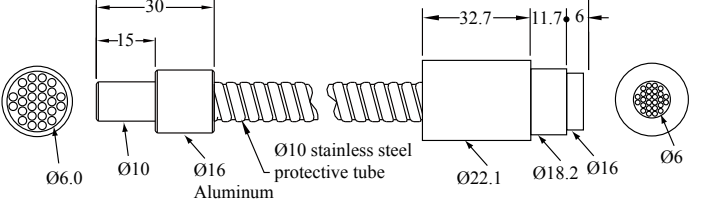
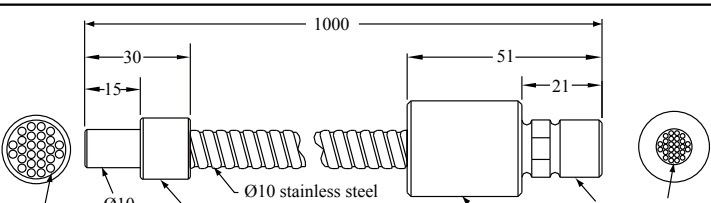
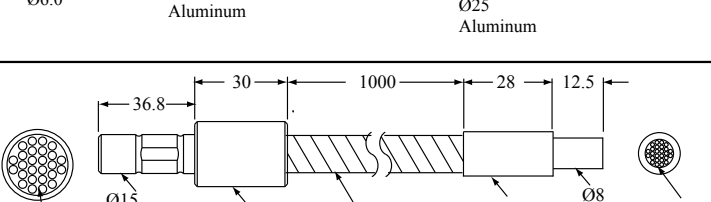
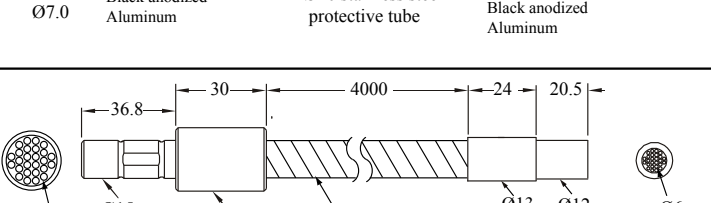
Type	Model	Dimensions	Wavelength	Individual fiber diameter	Operate temperature	Minimum bending radius
玻璃光導管 (Glass Fiber Light Guide) 標準型 (Thrubeam)	FGT-0815-10		380 ~ 1300nm	100 μm ± 4 μm	-40°C ~ +250°C	R30
	FGT-0808-10		380 ~ 1300nm	100 μm ± 4 μm	-40°C ~ +250°C	R30
	FGT-0815-20-H21		380 ~ 1300nm	100 μm ± 4 μm	-40°C ~ +250°C	R30
	FGT10-1415-30		380 ~ 1300nm	100 μm ± 4 μm	-40°C ~ +250°C	R31
	FGT-1016-20		380 ~ 1300nm	100 μm ± 4 μm	-40°C ~ +250°C	R30
	FGT-1015-10-H21		380 ~ 1300nm	100 μm ± 4 μm	-40°C ~ +250°C	R30
	FGT7-0815-10		380 ~ 1300nm	50 μm ± 4 μm	-40°C ~ +250°C	R30
	FGT-1215-10		380 ~ 1300nm	100 μm ± 4 μm	-40°C ~ +250°C	R30

Fiber

PR /PT

FR /FT

Glass Fiber

Light Guide

Silica Fiber

Access